

TWISTER

Folding table

Type list



Recommended retail prices
without assembly, without VAT

2150-1 - valid from 06|01|21

Contents	Page
Price categories and colour selection	3
Leg versions	4
Product description	5 - 7
Rectangular tables, depths 70 / 80 / 95 cm	8 - 9
Rectangular tables, rounded corners, depths 70/ 80/ 95 cm	10 - 11
Free form Tables	12
Modesty panel	13

Price category

	Table top
Price category 01 [PG 01]:	Melamine
Price category 02 [PG 02]:	Veneer 01
Price category 03 [PG 03]:	Veneer 02
Price category 04 [PG 04]:	Solid core

Table tops and edges

	Colour abbreviations		Table top 25 mm	Solid core 13 mm
Melamine finishes	top	edge		
Apple Merano Decor	AD	AD	■	
Beech Tirol Decor	BH	BH	■	
Beech Decor	BD	BD	■	
Lakeland Acacia Decor	LL	LL	■	
Cherry Romana Decor	KR	KR	■	
French Walnut Decor	ND	ND	■	
Oak Natural Finish	NE	NE	■	
Limed Oak Finish	EJ	EJ	■	
Moor Oak Finish	EE	EE	■	
Oak Milano Decor	ME	ME	■	
Olive Sevilla Decor	OD	OD	■	
Titanium white	TW	TW	■	
Platinum	PL	PL	■	
Dark anthracite	DA	DA	■	*Reflection factor does not comply with current standards
Anthracite	AZ	AZ	■	
Beige	BE	BE	■	
Beige-grey	GD	GD	■	
Volcano black	MS	MS	■	*Reflection factor does not comply with current standards
Cuando	CD	CD	■	
Veneer 01				
Beech Natur	BN	BN	■	
Beech with multiplex edg	BN	MB	■	
Ash black-grey	EX	EX	■	
Veneer 02				
American Cherry	KB	KB	■	
American Walnut	NU	NU	■	
Wenge	WG	WG	■	
Maple	AN	AN	■	
Oak Nature	PN	PN	■	
Top decor A* *For price determination please refer to p.Con data				
Chromix anthracite	YA	YA	■	
Halifax Oak*	H4	H4	■	*is a relief surface
Denver Oak	YB	YB	■	
Solid core				
Anthracite - black	PA			■
Titanium white - black	PT			■
Platinum - black	PV			■

Legs

	Option A Basic price	Option B Extra charge			
		191,00			
			Model 01	Model 02	Model 03
Cantilever	W2		polished alu	polished alu	polished alu
Head piece	W2		polished alu	polished alu	polished alu
Leg profile	E3		SE	E3	TW
Castor	W2		SZ	SZ	SZ
Covers	AZ		SZ	SZ	SZ

Caption:

W2 = white aluminium (RAL 9006)

E3 = white aluminium

SE = black anodised

SZ = black

AZ = anthracite

Please note:

The colour white aluminium (RAL 9006) may, depending on materials, structures or light conditions, show a slightly different colour character.

Recommended retail price in EURO - without VAT, without assembly.

TW 2150-1



Option A

Cantilever	W2
Head piece	W2
Leg profile	E3
Castor	W2
Covers	AZ



Option B

Cantilever	polished aluminium
Head piece	polished aluminium
Leg profile	SE
Castor	SZ
Covers	SZ

Top with protective edge



Option B

Cantilever	polished aluminium
Head piece	polished aluminium
Leg profile	E3
Castor	SZ
Covers	SZ

Top with protective edge

Caption:

W2 = white aluminium (RAL 9006)
 E3 = aluminium anodised
 SE = black anodised
 SZ = black
 AZ = anthracite

- 1 Trip handle
- 2 Cross traverse
- 3 Table connector variant 01
(variant 02 without image)
- 4 Leg profile
- 5 Cantilever
- 6 Castor
- 7 Crossbeam tray
- 8 Head piece
- 9 Table top

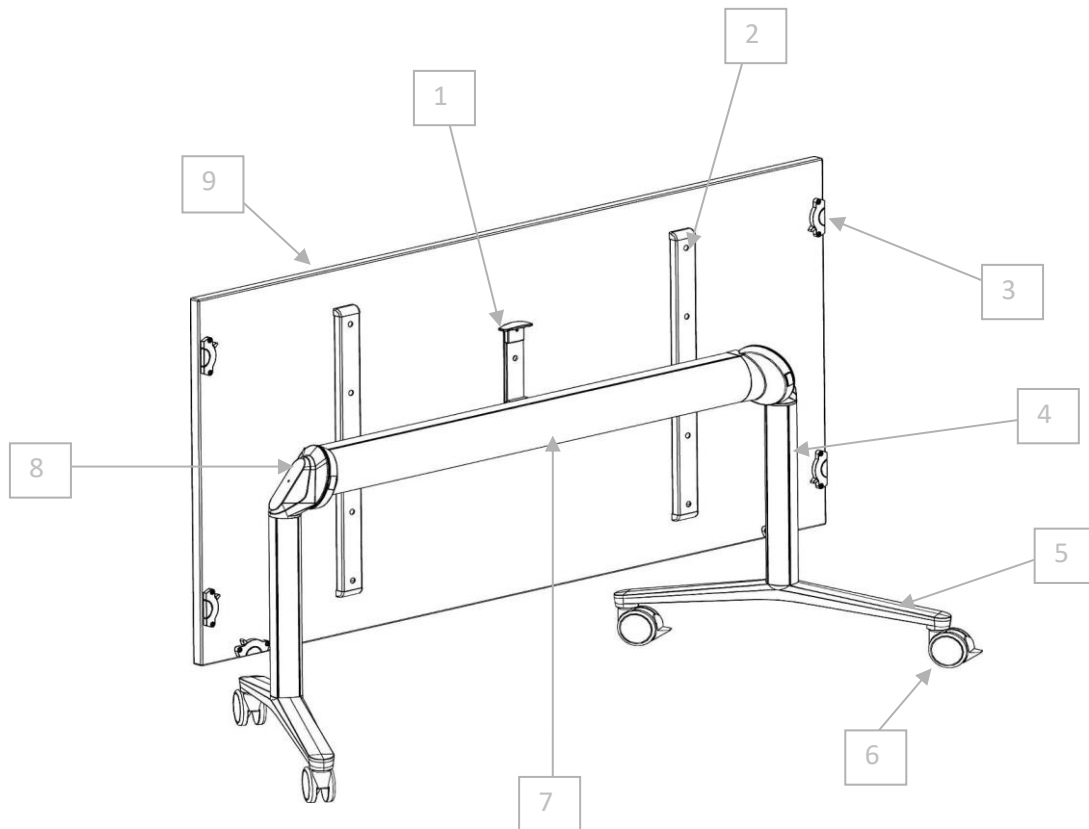

General information

TWISTER is a mobile folding table which can be handled easily.

The table is designed for highest stability in all positions, the mechanism combines two hinges on a tilted axis.

In the swivel area top and legs move automatically synchronised.

Thanks to its patented folding function TWISTER allows the realisation of multiple requirements at the workplace, regardless if it is as a temporary solitary work table, a generously dimensioned conference table or a variable educational furnishing solution.

TWISTER complies with the EU guideline 90/270 as well as all recent German norms and laws (Labour Protection Law, DIN EN 527,1-3, DIN Technical Report 147, DIN 4543-1, BGI 650 and BGR 234).

Under the terms of our Product Continuity policy, all parts subject to fair wear and tear must continue to be available for a period of 10 years from the time when a product is officially withdrawn from our range/portfolio. Excluded from this are fabrics, finishes and any components that require specific casts or tools to produce. Replacement parts do not have to be 100% identical provided that product functionality is not compromised.

Table tops



Material and surface

All table shapes are available melamine coated or veneered. To provide a smooth transition between the surface top and edge and thereby creating the illusion of a single flowing solid surface all melamine coated table tops have laser edgebands.

3-layer chipboards according to DIN 68765 standard, emission certified E1, 2.5cm thick, directly covered with melamine on both sides, resp. veneered on both sides are used. The top side of the veneered table tops is covered with the chosen veneer, the underside with the corresponding counterpart.

Depending on the variant, all edges are rounded with a 3mm strong ABS-edge banding or with a 3mm strong veneer edge, rounded with a radius of 3mm.

The rounded table tops are available with a protective edge subject to an additional charge.



The top surface is lightfast, mostly blend-free and extremely scratch-resistant.

Some table tops are also available with a 1.3cm thick solid core top:

Rectangular shape with rounded edges (radius = 6 cm) (starting from width 140.0 cm),

Tables with rounded edges and rounded sides.

Tables with rounded corners and all solid-core top tables have a top overlap of 14 cm.



without top overlap

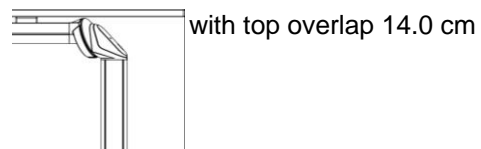

with top overlap 14.0 cm

Legs

Leg description

The TWISTER frame is designed as a column leg. Cantilever, column and head part are screwed together and attached to the cross beam. The frame will be supplied assembled.

The table is designed for highest stability in all positions, the mechanism combines two hinges on a tilted axis

In the swivel area top and legs move automatically synchronised.

Top quality materials guarantee a maximum life time:

cantilever	alu pressure casting
leg profile	alu strand casting
head piece	alu pressure casting
crossbeam tray	alu strand casting
cross traverse	powder-coated steel
trip handle	powder-coated steel
covers	polyamide (PA)

Every cantilever has two castors, one has a brake.

Table connector

The table can be connected with table connectors.

Two different models are available.

Model 01, for tables without protective edge:

This model is a force-locked connection underneath the table tops which is operated too-free.

Model 02, for tables with protective edge:

The plastic connectors are fitted together underneath the table top.

These connectors can be fixed at the side as well as at the rear underneath the table top.

Modesty panel

A modesty panel made of white acrylic glass is available for all Table shapes.

Environmental compatibility

TWISTER is made of very few materials, easy to separate: chipboard, aluminium, steel and polyamide can easily be recycled. No foams or other CfC-containing materials are used.

All steel and aluminium parts are powdered with solvent-free and eco-friendly lacquers.

The extruded aluminium sheaths are anodised.

According to the demands of the dangerous substances decree (§ 9 Abs.3.4) only chipboards of the emission class E1 are used. Veneer surfaces are protected with water based varnishes.

For protection of the furniture during the transport only reusable packaging material is used.



Rectangular tables

TWISTER

Leg option A

Extra charge

leg option B:

head piece and cantilever polished

column in 2 variants (see page 3-4)

191,00

78,00

without top overlap

with top overlap



without



14.0 cm per side

Depth 70.0 cm

height 74,0 cm/ 110,0 cm (Surcharge)

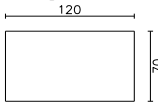

Width 120,0 cm

TW TIA120070

PG 01

PG 02

PG 03

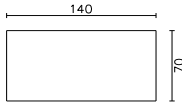

Width 140,0 cm

TW TIA140070

TW TIR140070

PG 01

PG 02

PG 03

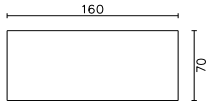

Width 160,0 cm

TW TIA160070

TW TIR160070

PG 01

PG 02

PG 03

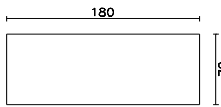

Width 180,0 cm

TW TIA180070

TW TIR180070

PG 01

PG 02

PG 03

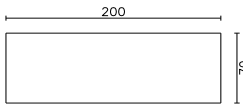

Width 200,0 cm

TW TIA200070

TW TIR200070

PG 01

PG 02

PG 03

Connection element 90°

Connection 70.0 / 70.0 cm

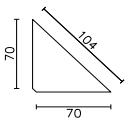

TW V3-707090

TW V3-707090

PG 01

PG 02

PG 03

Depth 80.0 cm

height 74,0 cm/ 110,0 cm (Surcharge)

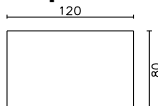

Width 120,0 cm

TW TIA120080

PG 01

PG 02

PG 03

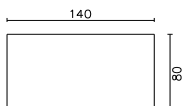

Width 140,0 cm

TW TIA140080

TW TIR140080

PG 01

PG 02

PG 03

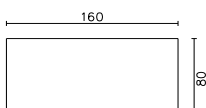

Width 160,0 cm

TW TIA160080

TW TIR160080

PG 01

PG 02

PG 03

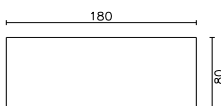

Width 180,0 cm

TW TIA180080

TW TIR180080

PG 01

PG 02

PG 03

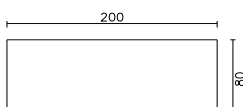

Width 200,0 cm

TW TIA200080

TW TIR200080

PG 01

PG 02

PG 03

Trapeze top

Connection 80.0 / 80.0 cm

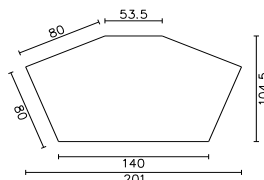

TW TP-202105

PG 01

PG 02

PG 03

Rectangular frame, width: 140 cm

Rectangular tables

TWISTER

Leg option A

Extra charge

leg option B:

head piece and cantilever polished column in 3 variants (see page 3-4)

Cut-out at back of table top

without top overlap

with top overlap

191,00

78,00



without

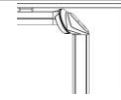

14.0 cm per side

Depth 95.0 cm

height 74,0 cm/ 110,0 cm (Surcharge)

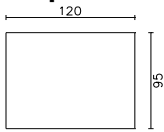

Width 120,0 cm

TW TIA120095

PG 01

PG 02

PG 03

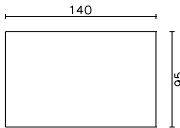

Width 140,0 cm

TW TIA140095

TW TIR140095

PG 01

PG 02

PG 03

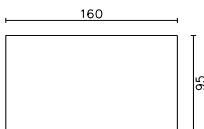

Width 160,0 cm

TW TIA160095

TW TIR160095

PG 01

PG 02

PG 03

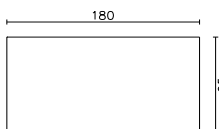

Width 180,0 cm

TW TIA180095

TW TIR180095

PG 01

PG 02

PG 03

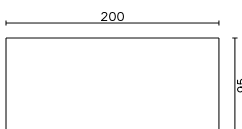

Width 200,0 cm

TW TIA200095

TW TIR200095

PG 01

PG 02

PG 03

Table connector



TW ZTI1000

fixed left and right
4 pcs

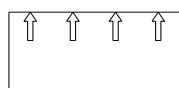

TW ZTI1050

rear fixing
4 pcs

TW ZTI1010

for additional fitting
2 pieces

Rectangular tables, rounded corners

TWISTER

Leg option A

without top overlap

with top overlap

Extra charge

leg option B:

191,00

head piece and cantilever polished

column in 3 variants (see page 3-4)

Cut-out at back of table top

78,00



without

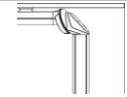

14.0 cm per side

depth 70.0 cm

height 74,0 cm/ 110,0 cm (Surcharge)

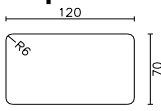

Width 120,0 cm

TW BIA120070

PG 01

PG 02

PG 03

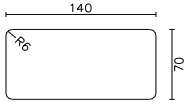

Width 140,0 cm

TW BIA140070

TW BIR140070

PG 01

PG 02

PG 03

PG 04

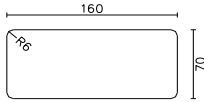

Width 160,0 cm

TW BIA160070

TW BIR160070

PG 01

PG 02

PG 03

PG 04

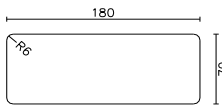

Width 180,0 cm

TW BIA180070

TW BIR180070

PG 01

PG 02

PG 03

PG 04

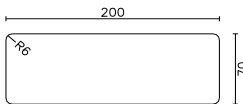

Width 200,0 cm

TW BIA200070

TW BIR200070

PG 01

PG 02

PG 03

PG 04

Connection element 90°

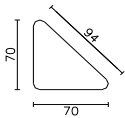

TW V3-707091

Connection 70.0 / 70.0 cm

TW V3-707091

PG 01

PG 02

PG 03

Depth 80.0 cm

height 74,0 cm/ 110,0 cm (Surcharge)

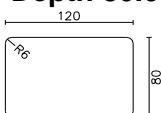

Width 120,0 cm

TW BIA120080

PG 01

PG 02

PG 03

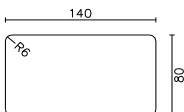

Width 140,0 cm

TW BIA140080

TW BIR140080

PG 01

PG 02

PG 03

PG 04

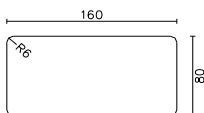

Width 160,0 cm

TW BIA160080

TW BIR160080

PG 01

PG 02

PG 03

PG 04

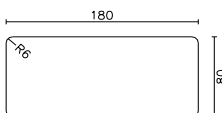

Width 180,0 cm

TW BIA180080

TW BIR180080

PG 01

PG 02

PG 03

PG 04

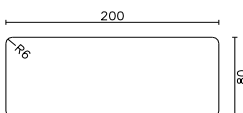

Width 200,0 cm

TW BIA200080

TW BIR200080

PG 01

PG 02

PG 03

PG 04

Rectangular tables, rounded corners

TWISTER

Leg option A

without top overlap

with top overlap

Mehrpreis:

Gestellausführung B:

Kopfstück und Kufe poliert.

Beinsäule in 3 Ausführungen (siehe Seite 3-4)

Cut-out at back of table top

191,00

78,00



without

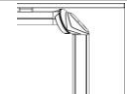

14.0 cm per side

Depth 95.0 cm

height 74,0 cm/ 110,0 cm (Surcharge)

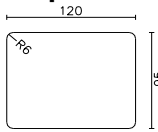

Width 120,0 cm

TW BIA120095

PG 01

PG 02

PG 03

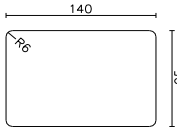

Width 140,0 cm

TW BIA140095

TW BIR140095

PG 01

PG 02

PG 03

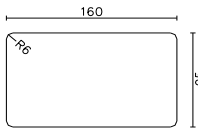

Width 160,0 cm

TW BIA160095

TW BIR160095

PG 01

PG 02

PG 03

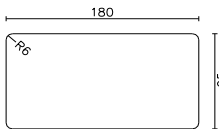

Width 180,0 cm

TW BIA180095

TW BIR180095

PG 01

PG 02

PG 03

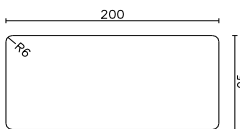

Width 200,0 cm

TW BIA200095

TW BIR200095

PG 01

PG 02

PG 03

Optional accessories

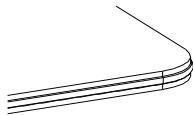

Extra charge per table

69,00

Protective edge
(not for PG 04)

Table connector for table tops without protective edge



TW ZTI1000

fixed left and right
4 pcs

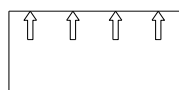

TW ZTI1050

rear fixing
4 pcs

TW ZTI1010

for additional fitting
2 pieces

Table connector for table tops with protective edge



TW ZTI1100

fixed left and right
4 pcs

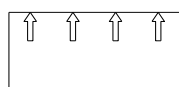

TW ZTI1150

rear fixing
4 pcs

TW ZTI1110

for additional fitting
2 pieces

Free form tables

TWISTER

Leg option A

with top overlap

Mehrpreis:

Gestellausführung B:

Kopfstück und Kufe poliert.

Beinsäule in 3 Ausführungen (siehe Seite 3-4)

Cut-out at back table top

191,00

78,00

14.0 cm per side



Depth 70.0 cm

height 74,0 cm/ 110,0 cm (Surcharge)

Table connector not possible!

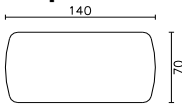

Width 140,0 cm

TW RIG140070

PG 01

PG 02

PG 03

PG 04

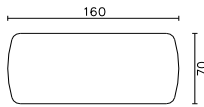

Width 160,0 cm

TW RIG160070

PG 01

PG 02

PG 03

PG 04

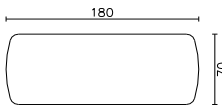

Width 180,0 cm

TW RIG180070

PG 01

PG 02

PG 03

PG 04

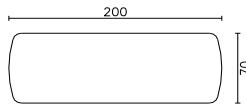

Width 200,0 cm

TW RIG200070

PG 01

PG 02

PG 03

PG 04

Depth 80.0 cm

height 74,0 cm/ 110,0 cm (Surcharge)

Table connector not possible!

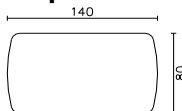

Width 140,0 cm

TW RIG140080

PG 01

PG 02

PG 03

PG 04

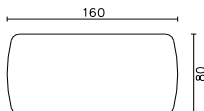

Width 160,0 cm

TW RIG160080

PG 01

PG 02

PG 03

PG 04

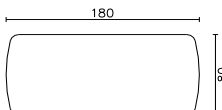

Width 180,0 cm

TW RIG180080

PG 01

PG 02

PG 03

PG 04

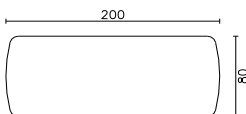

Width 200,0 cm

TW RIG200080

PG 01

PG 02

PG 03

PG 04

Ellipse

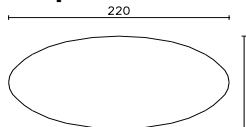

Width 220,0 cm

TW BT-220100

PG 01

PG 02

PG 03

Table connector not possible!

Sickle shaped top

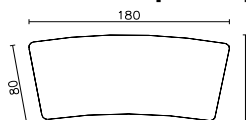

Width 180,0 cm

TW ST-186085

PG 01

PG 02

PG 03

Optional accessories

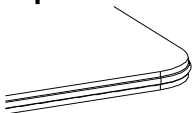

Protective edge

surcharge per table

69,00

(not for PG 04)

Modesty panel

TWISTER

without top overlap



with top overlap



14.0 cm per side

A1: Acrylic glass white

Width of top 120.0 cm

TW R0-1208-O

A1

Width of top 140.0 cm

TW R0-1408-O

TW R0-1408-M

A1

Width of top 160.0 cm

TW R0-1608-O

TW R0-1608-M

A1

Width of top 180.0 cm

TW R0-1808-O

TW R0-1808-M

A1

Width of top 200.0 cm

TW R0-2008-O

TW R0-2008-M

A1

Ellipse

TW R0-1808-O

A1

Sickle shaped top

TW R0-1608-O

A1

WINI Büromöbel
Georg Schmidt GmbH & Co. KG

Auhagenstraße 79
31863 Coppenbrügge, OT Marienau
Germany

Telefon: +49(0)5156/979-0
Telefax: +49(0)5156/979-100

E-Mail: info@wini.de
Internet: www.wini.de